



REVISIONS

LTR	DESCRIPTION	DATE	DWN	APVD
A	RELEASED	01Jan16	AW	WK

◆ 技术参数/Technical parameters

- 符合规范/Accord With Norm :EIA-364C
- 额定电流/Current Rating :1AMP
- 绝缘阻抗/Insulator Resistance :500MΩ Min.
- 接触阻抗/Contact Resistance :30mΩ Max.
- 耐电压值/Voltage Resistance :AC 250V
- 工作温度/Operating Temperature :-40℃ To +85℃
- 金属材料/Metallic Material :Phosphor Bronze
- 金属处理/Metal Treatment :Au 3u", Sn 120u"
- 绝缘材料/Insulator Material :LCP UL94V-0
- 耐焊接热/Resistance To Soldering Heat :275° C ±5° C 10S MAX

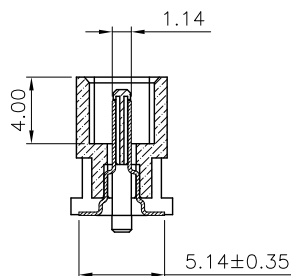
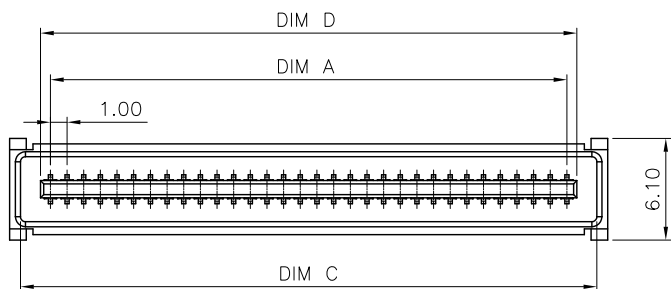

剖面 A-A
比例 1: 1

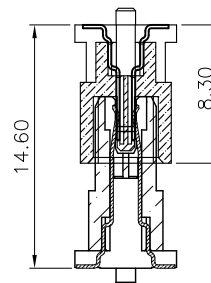
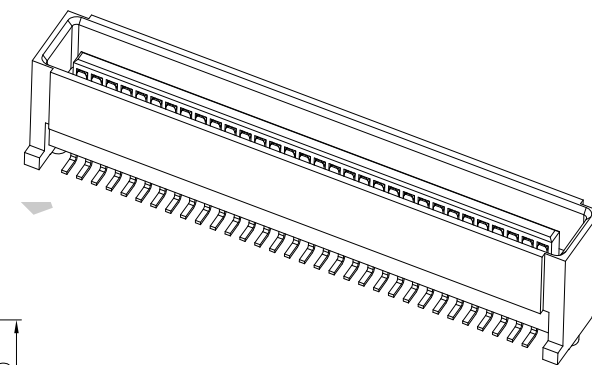
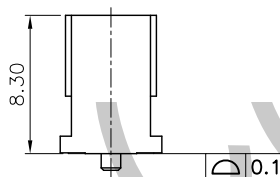
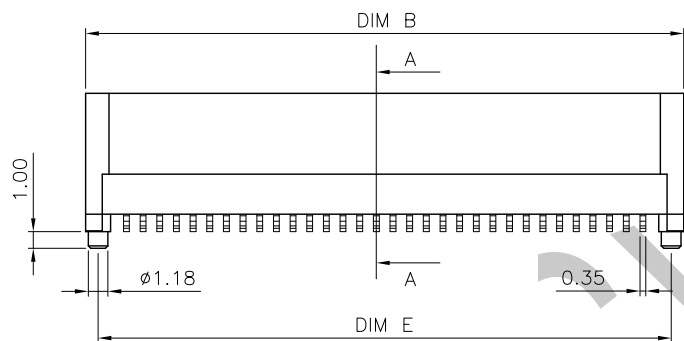

装配高

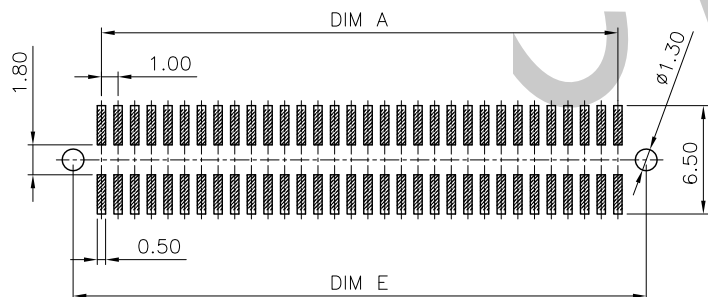

TOLERANCE: ±0.05
RECOMMENDED PCB LAYOUT
(TOP VIEW)

52.40	50.20	52.60	53.90	49.00	2X50P	BTB100-250-002
34.40	32.20	34.60	35.90	31.00	2X32P	BTB100-232-002
DIM E	DIM D	DIM C	DIM B	DIM A	PIN NO.	PART NUMBER (料号)

THIS DRAWING IS A CONTROLLED DOCUMENT.		DWN	01Jan2016	东莞市宇亮电子有限公司 DONG GUAN YU LIANG ELECTRONICS CO., LTD NAME 1.0 mm 间距 板对板 插座 H=8.3 2xNpin, VERTICAL, SMT.			
DIMENSIONS: mm		A. WU					
TOLERANCES UNLESS OTHERWISE SPECIFIED:		CHEK	01Jan2016				
THIRD ANGLE PROJECTION		S. CHIEN					
0 PLC ± 0.50 1 PLC ± 0.30 2 PLC ± 0.20 3 PLC ± 0.15 4 PLC ± - ANGLES ± 3°		APVD	01Jan2016	SIZE	DRAWING No. (图号)		
		Abel		A4	YL-ED-01437		
		PRODUCT SPEC		CUSTOMER DRAWING	SCALE	1 : 1	
		WEIGHT				SHEET	1 of 1